

N-Channel Enhancement-Mode MOSFET (30V, 5.8A)

PRODUCT SUMMARY

V_{DSS}	I_D	$R_{DS(on)}$ (m Ω) Max
30V	5.8A	32 @ $V_{GS} = 10V, I_D = 5.8A$
		35 @ $V_{GS} = 4.5V, I_D = 5.0A$
		52 @ $V_{GS} = 2.5V, I_D = 4.0A$

Features

- Super high dense cell trench design for low $R_{DS(on)}$
- Rugged and reliable
- SOT-23 package
- Ordering information:GN3400(Lead(Pb)-free and halogen-free)



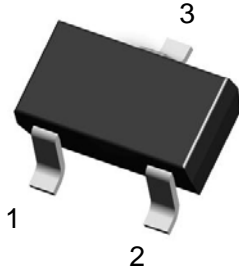

GN3400 Pin Assignment & Symbol

3-Lead Plastic **SOT-23**
Pin 1: Gate 2: Source 3: Drain

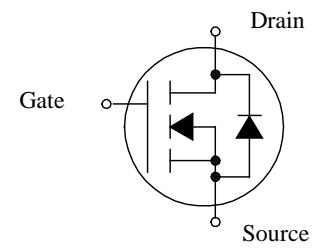

Absolute Maximum Ratings ($T_A=25^{\circ}C$, unless otherwise noted)

Symbol	Parameter	Ratings	Units
V_{DS}	Drain-Source Voltage	30	V
V_{GS}	Gate-Source Voltage	± 12	V
I_D	Drain Current (Continuous)	5.8	A
I_{DM}	Drain Current (Pulsed) ^a	24	A
I_S	Drain-Source Diode Forward Current	2.5	A
P_D	Total Power Dissipation @ $T_A=25^{\circ}C$	1.25	W
T_j, T_{stg}	Operating Junction and Storage Temperature Range	-55 to +150	$^{\circ}C$
$R_{\theta JA}$	Thermal Resistance Junction to Ambient ^b	100	$^{\circ}C/W$

Note: a: Repetitive Rating; Pulse width limited by the maximum junction temperature.

b: 1-in2 2oz Cu PCB board

Electrical Characteristics (T_A=25°C, unless otherwise noted)

Symbol	Characteristic	Test Conditions	Min.	Typ.	Max.	Unit
• Off Characteristics						
BV _{DSS}	Drain-Source Breakdown Voltage	V _{GS} =0V, I _D =250μA	30	-	-	V
I _{DSS}	Zero Gate Voltage Drain Current	V _{DS} =24V, V _{GS} =0V	-	-	1	μA
I _{GSS}	Gate-Body Leakage Current	V _{GS} =±12V, V _{DS} =0V	-	-	±100	nA
• On Characteristics^c						
V _{GS(th)}	Gate Threshold Voltage	V _{DS} =V _{GS} , I _D =250μA	0.7	-	1.4	V
R _{DS(on)}	Drain-Source On-State Resistance	V _{GS} =2.5V, I _D =4.0A	-	46	52	mΩ
		V _{GS} =4.5V, I _D =5.0A	-	32	35	
		V _{GS} =10V, I _D =5.8A	-	28	32	
g _{FS}	Forward Transconductance	V _{DS} =5V, I _D =5.0A	-	11	-	S
• Dynamic Characteristics^d						
C _{iss}	Input Capacitance	V _{DS} =15V, V _{GS} =0V, f=1MHz	-	560	-	PF
C _{oss}	Output Capacitance		-	58	-	
C _{rss}	Reverse Transfer Capacitance		-	47	-	
• Switching Characteristics^d						
Q _g	Total Gate Charge	V _{DS} =15V, I _D =3A, V _{GS} =10V	-	5	-	nC
Q _{gs}	Gate-Source Charge		-	0.9	-	
Q _{gd}	Gate-Drain Charge		-	14	-	
t _{d(on)}	Turn-on Delay Time	V _{DD} =15V, R _L =15Ω, I _D =1A, V _{GEN} =10V, R _G =6Ω	-	7.15	-	nS
t _r	Turn-on Rise Time		-	2.3	-	
t _{d(off)}	Turn-off Delay Time		-	29.3	-	
t _f	Turn-off Fall Time		-	2.9	-	
• Drain-Source Diode Characteristics						
V _{SD}	Drain-Source Diode Forward Voltage	V _{GS} =0V, I _S =2.5A	-	-	1.2	V

Note: c : Pulse Test : Pulse Width < 300μs, Duty Cycle < 2%.

d: Guaranteed by design, not subject to production testing

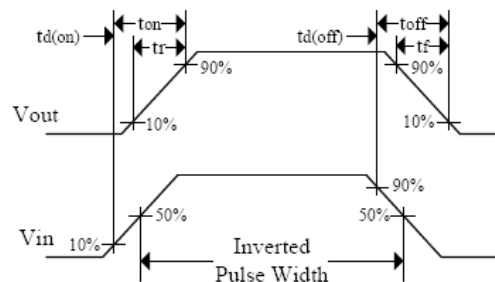
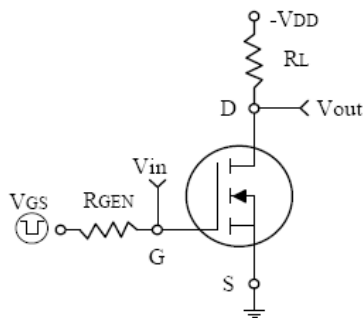

Switching Test Circuit and Switching Waveforms

Characteristics Curve

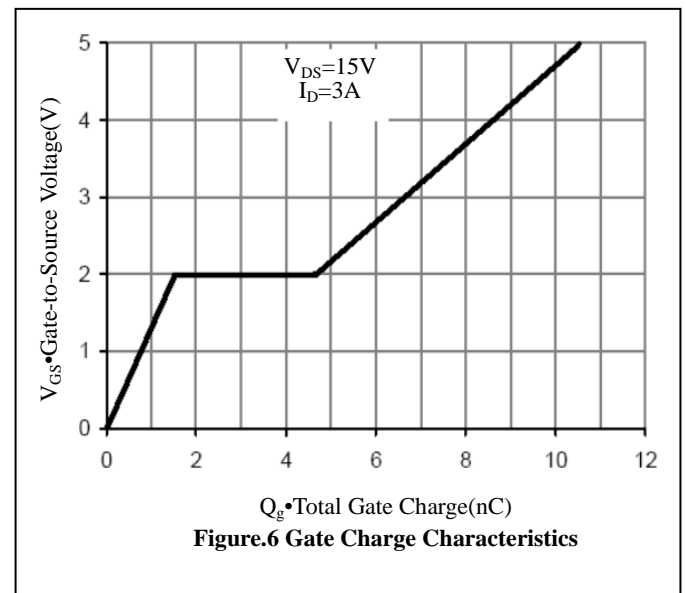
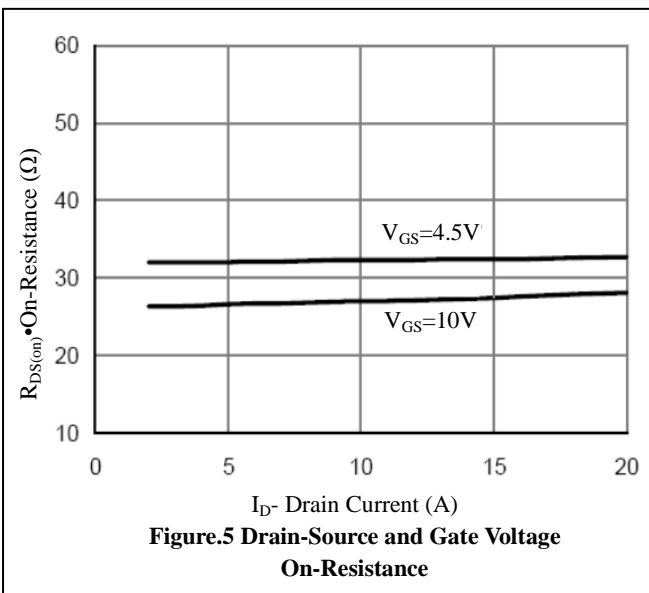
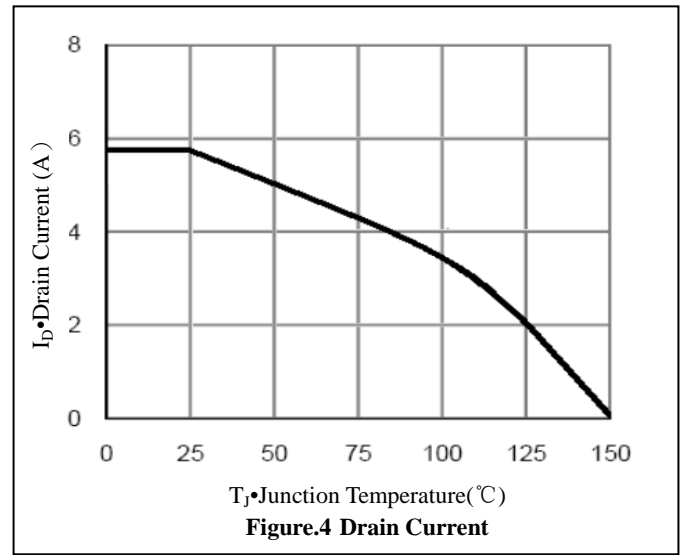
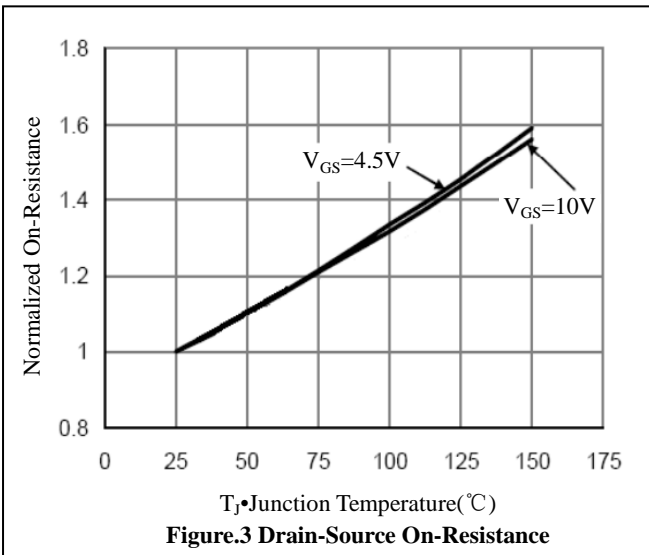
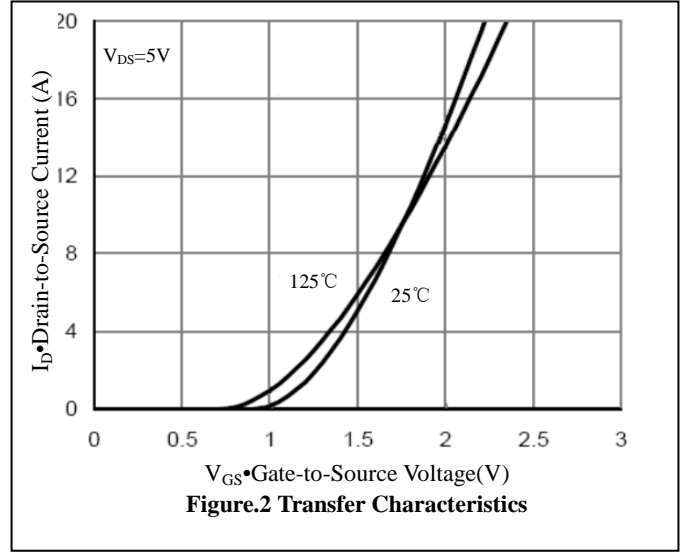
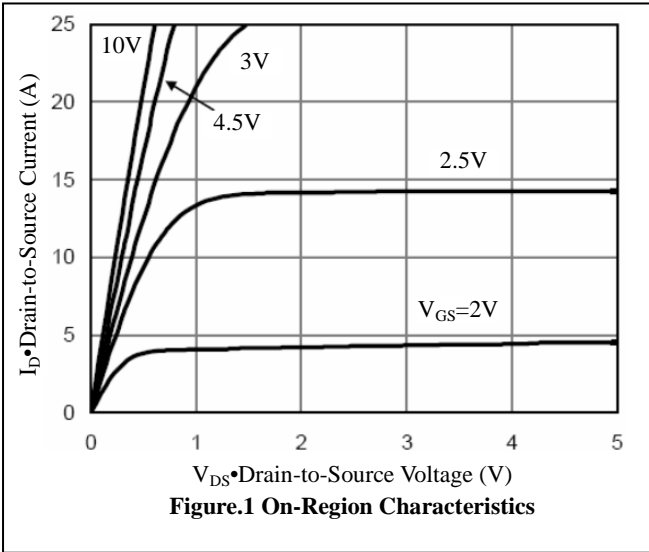

Characteristics Curve

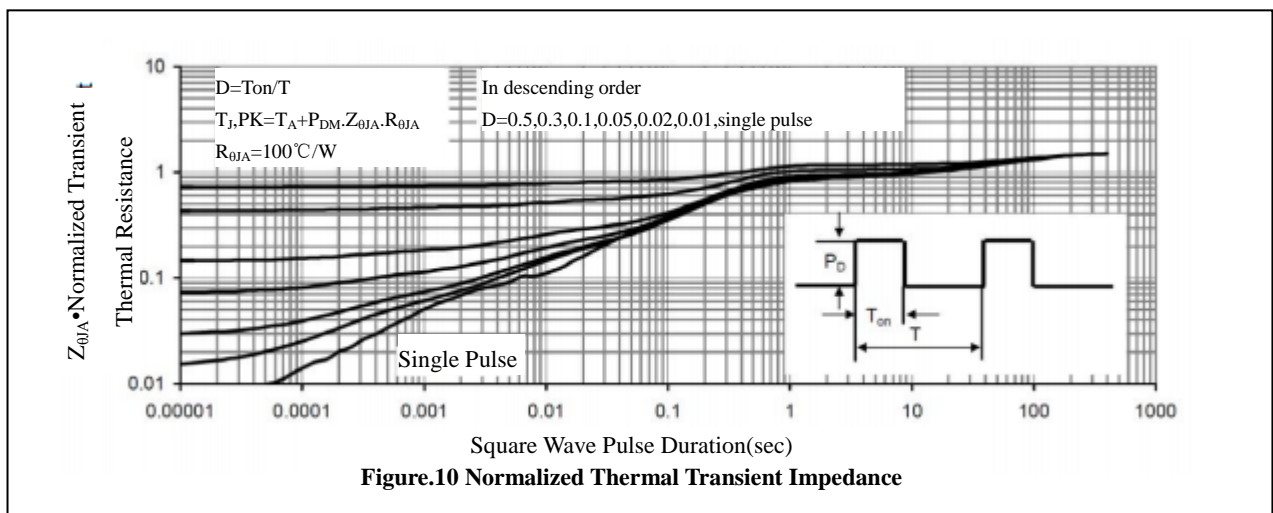
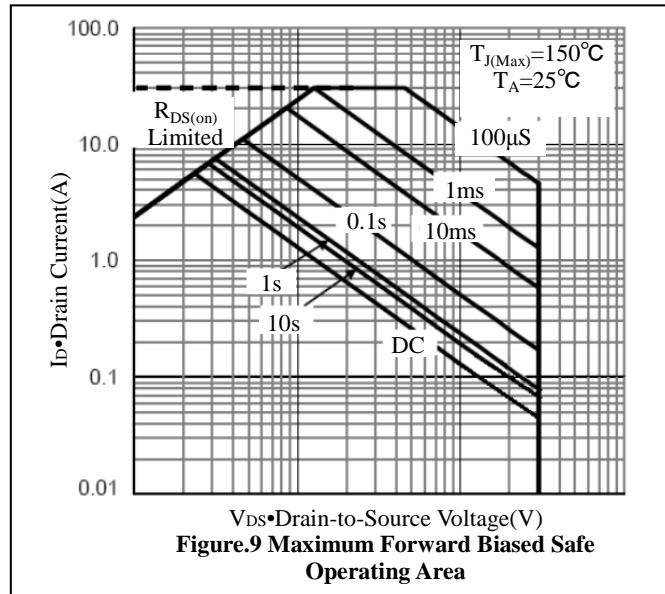
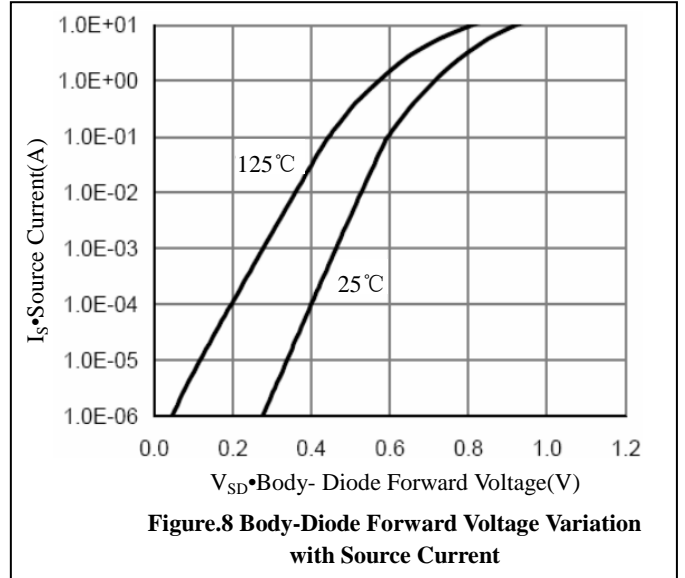
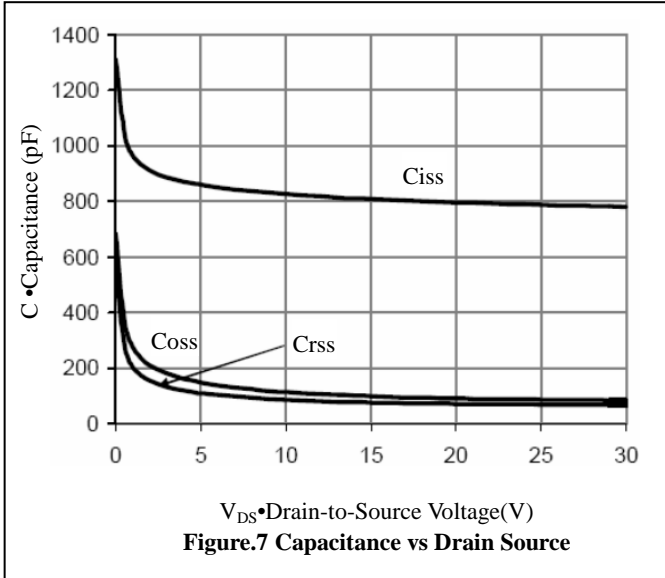

SOT-23 PACKAGE OUTLINE DIMENSIONS

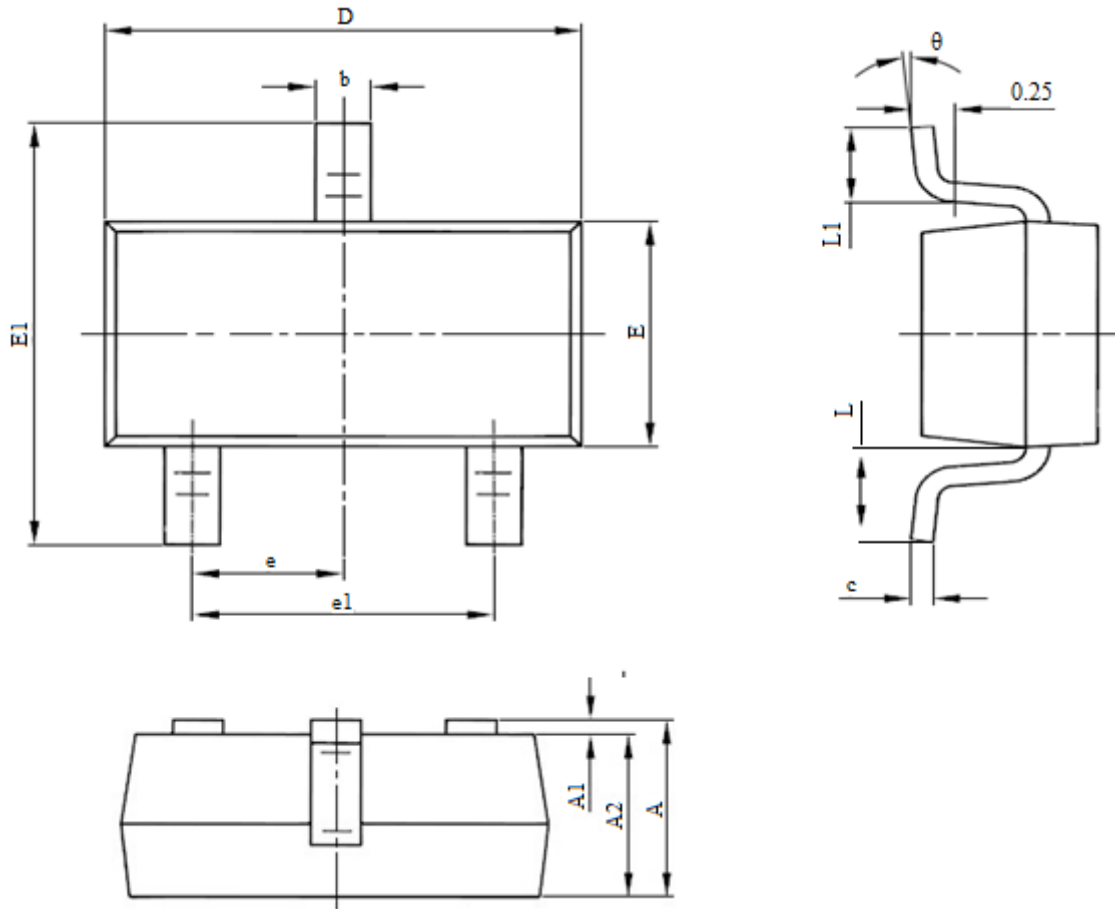

Symbol	Dimensions In Millimeters		Dimensions In Inches	
	Min	Max	Min	Max
A	0.9	1.15	0.035	0.045
A1	0	0.1	0	0.004
A2	0.9	1.05	0.035	0.041
b	0.3	0.5	0.012	0.020
c	0.08	0.15	0.003	0.006
D	2.8	3	0.11	0.118
E	1.2	1.4	0.047	0.055
E1	2.25	2.55	0.089	0.1
e	0.95(BSC)		0.037(BSC)	
e1	1.8	2	0.071	0.079
L	0.55REF		0.022REF	
L	0.3	0.5	0.012	0.02
θ	0°	8°	0°	8°



Notice

1. Specification of the products displayed herein is subject to change without notice. Continuous development may necessitate changes in technical data without notice. GEMMICRO or anyone on its behalf assumes no responsibility or liability for any errors or inaccuracies.
2. Stresses beyond those listed under “Absolute Maximum Ratings” may cause permanent damage to the device. These are stress ratings only and functional operation of the device at these or any other conditions beyond those indicated in the operational sections of the specifications are not implied. Exposure to absolute maximum rating conditions for extended periods may affect device reliability.