

N-Channel Enhancement Mode MOSFET (100V, 15A)

PRODUCT SUMMARY		
V_{DSS}	I_D	$R_{DS(on)}$ (m Ω) Max.
100V	15A	100@ $V_{GS} = 10V, I_D = 15A$
		140@ $V_{GS} = 4.5V, I_D = 10A$

Features

- Rugged and reliable
- Surface Mount package
- High power and current handling capability.
- Super high dense cell design for extremely low $R_{DS(on)}$.
- Ordering information : GD15N10(Lead(Pb)-free and halogen-free)



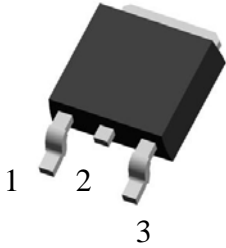

GD15N10 Pin Assignment & Symbol

3-Lead Plastic **TO-252**
Pin 1: Gate Pin2: Drain Pin3: Source

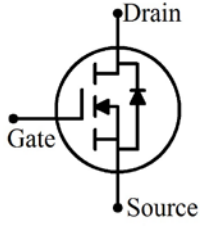

Absolute Maximum Ratings ($T_A = 25^\circ\text{C}$, unless otherwise noted)

Symbol	Parameter	Ratings	Unit
V_{DS}	Drain-Source Voltage	100	V
V_{GS}	Gate-Source Voltage	± 20	V
I_D	Drain Current (Continuous)	15	A
I_{DM}^a	Drain Current (Pulsed)	65	A
P_D	Total Power Dissipation @ $T_A = 25^\circ\text{C}$	2.5	W
I_{AS}^c	Avalanche Current, Single Pulse @ $L=0.5\text{mH}$	10	A
E_{AS}^c	Avalanche Energy, Single Pulse @ $L=0.5\text{mH}$	25	mJ
I_S	Maximum Diode Forward Current	3	A
T_{stg}	Storage Temperature Range	- 55 to +150	$^\circ\text{C}$
T_j	Junction Temperature	150	$^\circ\text{C}$
$R_{\theta JA}^b$	Thermal Resistance Junction to Ambient (PCB mounted)	50	$^\circ\text{C/W}$

Note: a: Repetitive Rating: Pulse width limited by the maximum junction temperature
 b: 1-in² 2oz Cu PCB board
 c: Repetitive rating, pulse width limited by junction temperature $T_j = 25^\circ\text{C}$

Electrical Characteristics (T_A=25°C, unless otherwise noted)

Symbol	Characteristic	Test Conditions	Min.	Typ.	Max.	Unit
• Off Characteristics						
BV _{DSS}	Drain-Source Breakdown Voltage	V _{GS} = 0V, I _D = 250μA	100	-	-	V
I _{DSS}	Zero Gate Voltage Drain Current	V _{DS} = 80V, V _{GS} = 0V	-	-	1	μA
I _{GSS}	Gate-Body Leakage Current	V _{GS} = ± 20V, V _{DS} = 0V	-	-	±100	nA
• On Characteristics ^d						
V _{GS(th)}	Gate Threshold Voltage	V _{DS} = V _{GS} , I _D = 250μA	1	-	2.5	V
I _{DS(on)}	On-State Drain Current	V _{DS} = 10V, V _{GS} = 10V	65	-	-	A
R _{DS(on)}	Drain-Source On-State Resistance	V _{GS} = 10V, I _D = 15A	-	78	100	mΩ
		V _{GS} = 4.5V, I _D = 10A	-	85	140	
g _{FS}	Forward Transconductance	V _{DS} = 10V, I _D = 15A	-	15	-	S
• Dynamic Characteristics ^e						
C _{iss}	Input Capacitance	V _{DS} = 50V, V _{GS} = 0V, f = 1MHz	-	880	-	pF
C _{oss}	Output Capacitance		-	60	-	
C _{rss}	Reverse Transfer Capacitance		-	28	-	
• Switching Characteristics ^e						
Q _g	Total Gate Charge	V _{DS} = 50V, I _D = 5.0A, V _{GS} = 5V	-	26	-	nC
Q _{gs}	Gate-Source Charge		-	3.3	-	
Q _{gd}	Gate-Drain Charge		-	6.5	-	
t _{d(on)}	Turn-on Delay Time	V _{DD} = 30V, R _L = 6.8Ω, I _D = 4.4A, V _{GEN} = 4.5V, R _G = 1Ω	-	15	-	nS
t _r	Turn-on Rise Time		-	5	-	
t _{d(off)}	Turn-off Delay Time		-	25	-	
t _f	Turn-off Fall Time		-	7	-	
• Drain-Source Diode Characteristics						
V _{SD}	Drain-Source Diode Forward Voltage	V _{GS} = 0V, I _S = 2A	-	-	1.3	V

Note: d: Pulse Test : Pulse Width < 300μs, Duty Cycle < 2%

e: Guaranteed by design, not subject to production testing.

Test Circuit

1、E_{AS} test circuit

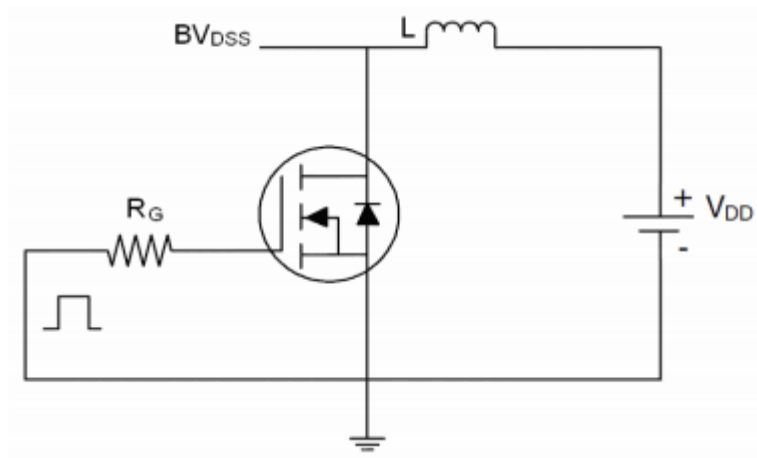

2、Gate charge test Circuit

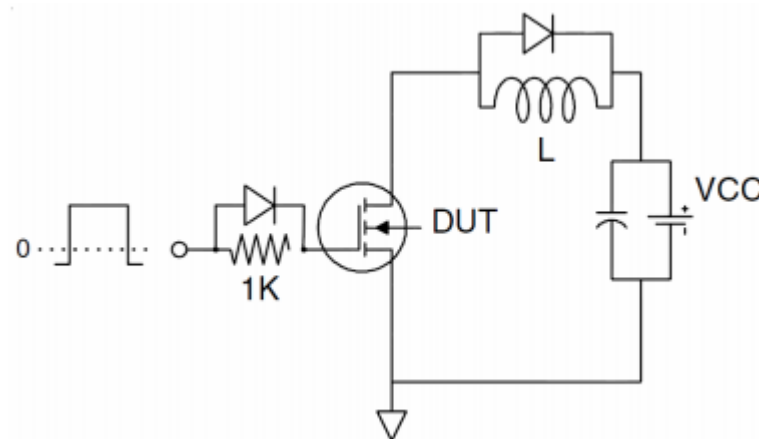

3、Switch Time Test Circuit

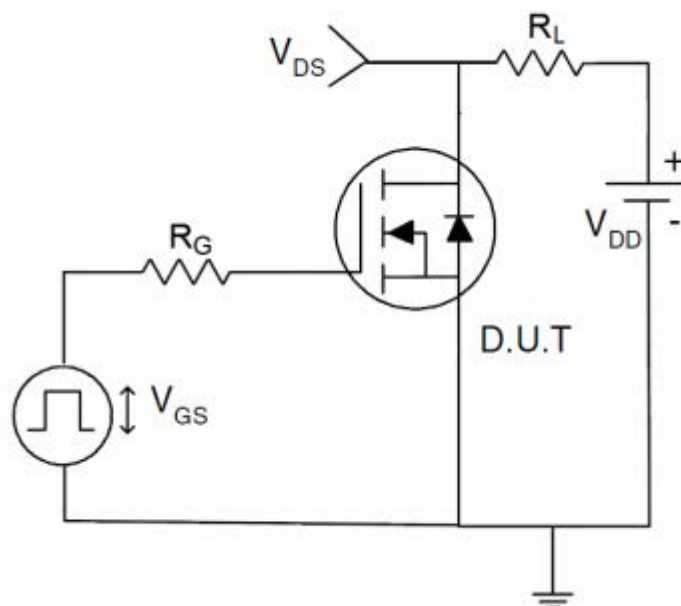

Characteristics Curve

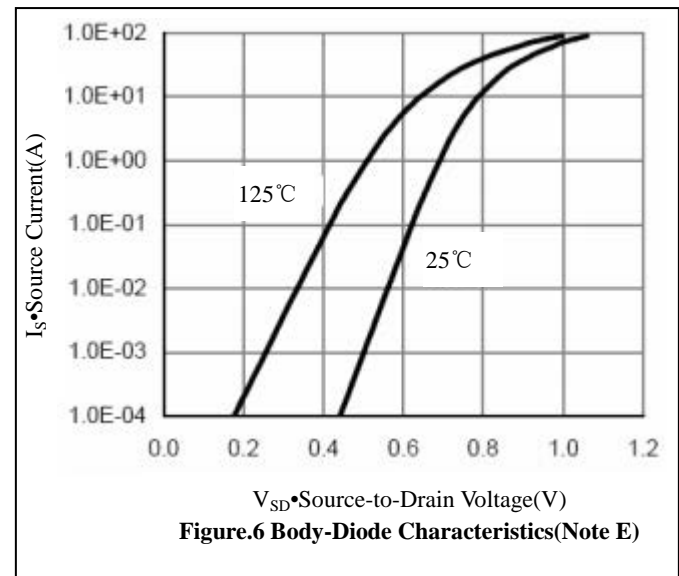
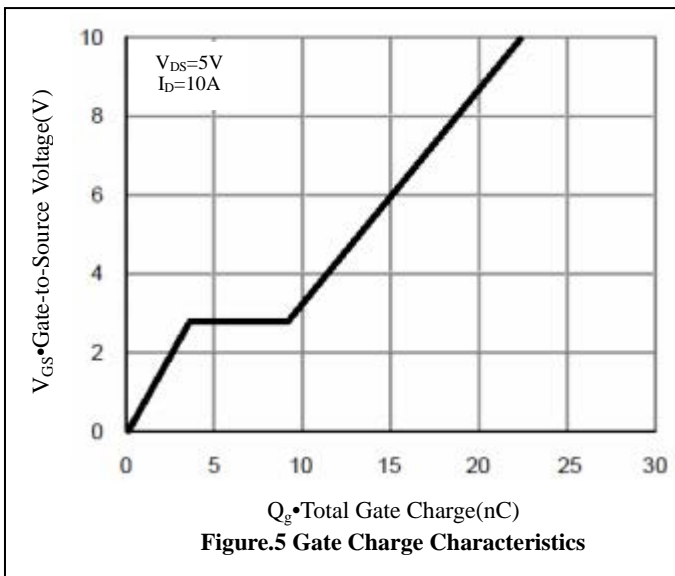
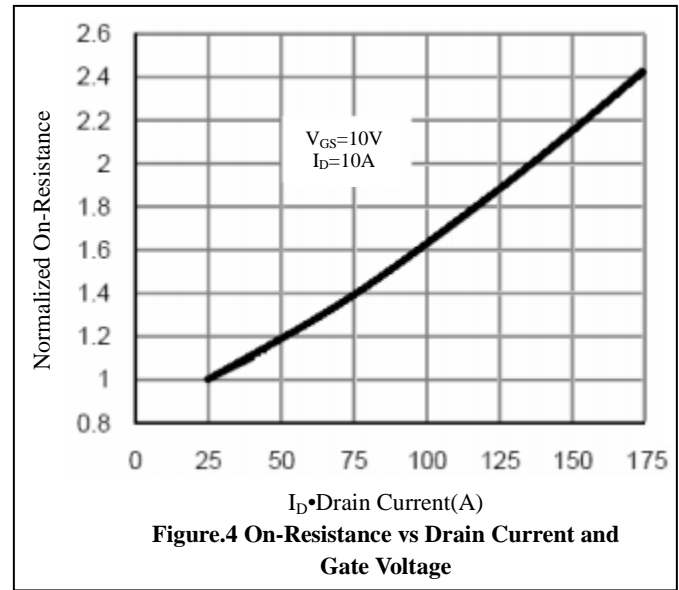
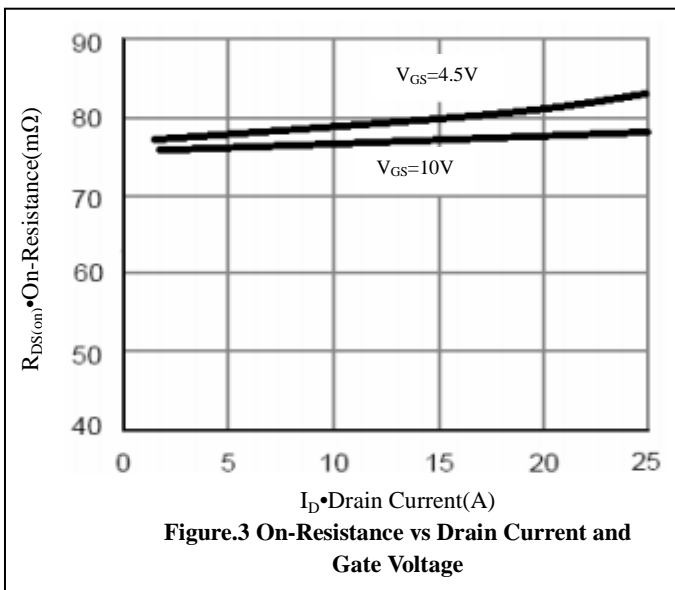
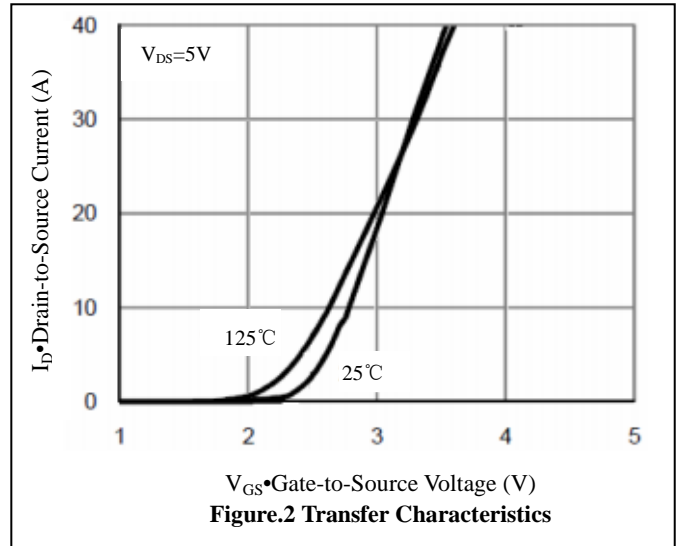
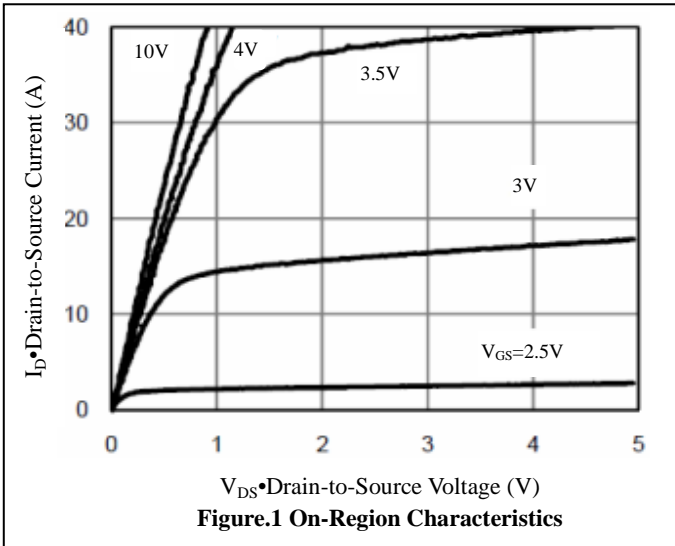

Characteristics Curve

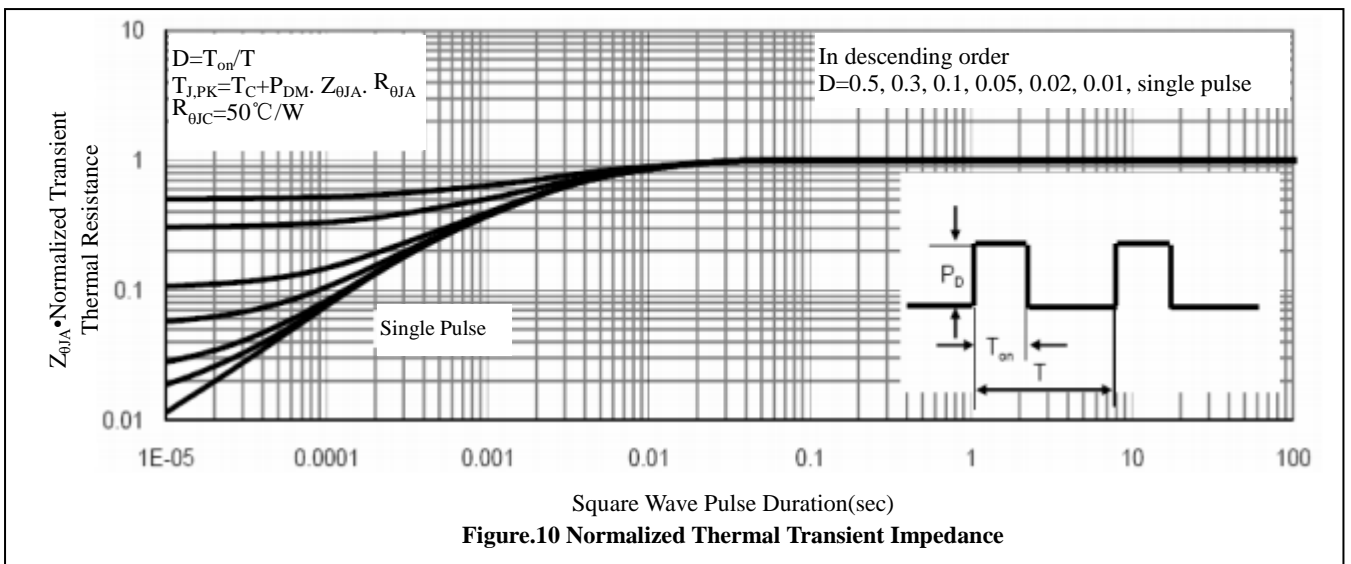
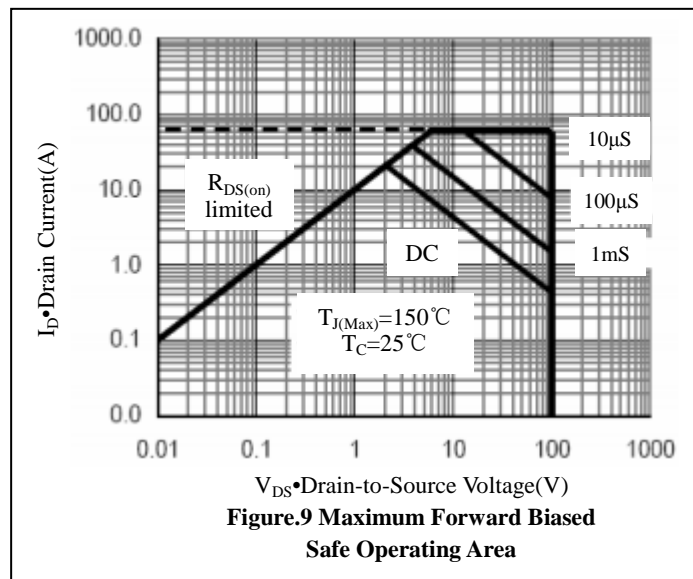
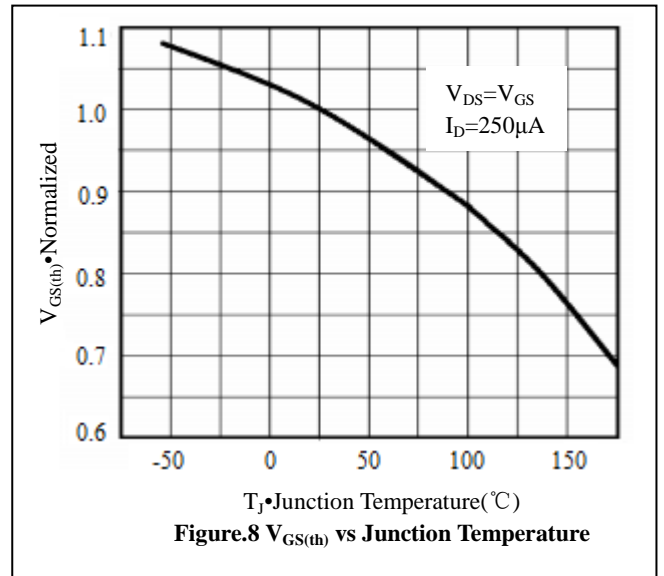
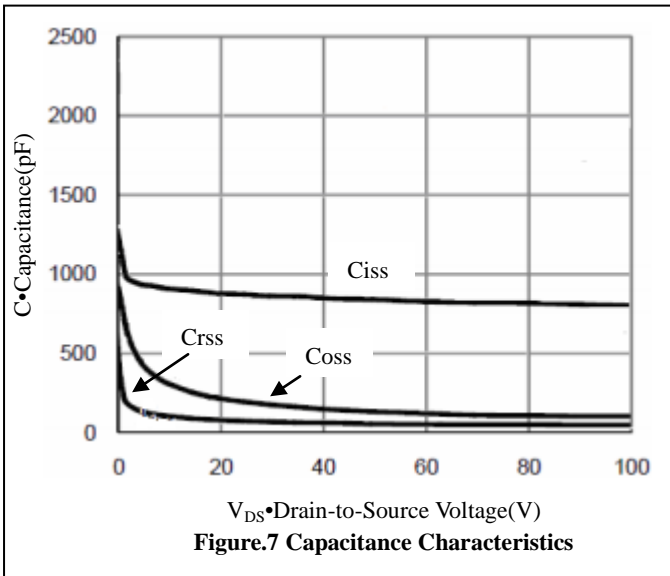

TO-252 Package Information

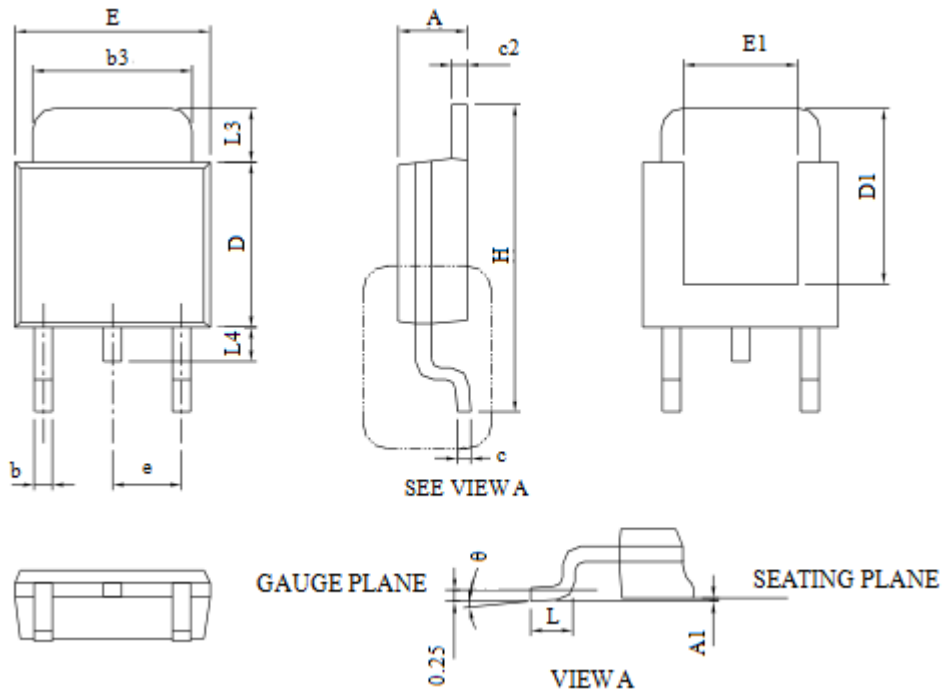

Symbol	Dimensions In Millimeters(MM)		Dimensions In Inches(MIL)	
	Min	Max	Min	Max
A	2.180	2.390	0.086	0.094
A1	0.000	0.130	0.000	0.005
b	0.500	0.890	0.020	0.035
b3	4.950	5.460	0.195	0.215
c	0.460	0.610	0.018	0.024
c2	0.460	0.890	0.018	0.035
D	5.330	6.220	0.21	0.245
D1	4.570	6.000	0.180	0.236
E	6.350	6.730	0.250	0.265
E1	3.810	6.000	0.150	0.236
e	2.290BSC		0.090BSC	
H	9.400	10.41	0.370	0.410
L	0.900	1.780	0.0035	0.070
L3	0.890	2.030	0.035	0.080
L4	0000	1.020	0000	0.040
θ	0°	8°	0°	8°



Notice

1. Specification of the products displayed herein is subject to change without notice. Continuous development may necessitate changes in technical data without notice. GEMMICRO or anyone on its behalf assumes no responsibility or liability for any errors or inaccuracies.
2. Stresses beyond those listed under “Absolute Maximum Ratings” may cause permanent damage to the device. These are stress ratings only and functional operation of the device at these or any other conditions beyond those indicated in the operational sections of the specifications are not implied. Exposure to absolute maximum rating conditions for extended periods may affect device reliability.