

Complementary High Density Trench MOSFET

PRODUCT SUMMARY (N-Channel)		
V_{DSS}	I_D	$R_{DS(on)}$ (m Ω) Max
40V	7A	28 @ $V_{GS} = 10V, I_D = 6.5A$
		42 @ $V_{GS} = 4.5V, I_D = 5.0A$

PRODUCT SUMMARY (P-Channel)		
V_{DSS}	I_D	$R_{DS(on)}$ (m Ω) Max
-40V	-5A	42 @ $V_{GS} = -10V, I_D = -6.0A$
		70 @ $V_{GS} = -4.5V, I_D = -5A$

Features

- Advanced Trench Process Technology
- High Density Cell Design for Ultra Low On-Resistance
- Surface mount Package
- Ordering information: GS4618 (Lead (Pb) - free and halogen - free)



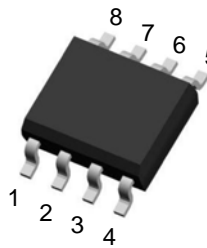

Pin 1: Source N
 Pin 2: Gate N
 Pin 3: Source P
 Pin 4: Gate P
 Pin 5 / 6: Drain P
 Pin 7 / 8: Drain N

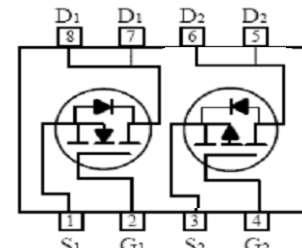

SOP-8

Absolute Maximum Ratings ($T_A = 25^\circ\text{C}$, unless otherwise noted)

Symbol	Parameter	N-Channel	P-Channel	Units
V_{DS}	Drain-Source Voltage	40	-40	V
V_{GS}	Gate-Source Voltage	± 12	± 12	V
I_D	Drain Current	7	-5	A
I_{DM}	Pulsed Drain Current ^a	30	-30	A
I_S	Drain-Source Diode Forward Current ^c	2.5	-2.3	A
P_D	Total Power Dissipation @ $T_A = 25^\circ\text{C}$	2.0	2.0	W
T_j, T_{stg}	Operating Junction and Storage Temperature Range	-55 to +150	-55 to +150	$^\circ\text{C}$
$R_{\theta JA}$	Thermal Resistance Junction to Ambient ^b	62.5	62.5	$^\circ\text{C}/\text{W}$

N-Channel Electrical Characteristics (T_A=25°C, unless otherwise noted)

Symbol	Characteristic	Test Conditions	Min.	Typ.	Max.	Unit
• Off Characteristics						
BV _{DSS}	Drain-Source Breakdown Voltage	V _{GS} =0V, I _D =250μA	40	-	-	V
I _{DSS}	Zero Gate Voltage Drain Current	V _{DS} =32V, V _{GS} =0V	-	-	-1	μA
I _{GSS}	Gate-Body Leakage Current	V _{GS} =±12V, V _{DS} =0V	-	-	±100	nA
• On Characteristics^c						
V _{GS(th)}	Gate Threshold Voltage	V _{DS} =V _{GS} , I _D =250μA	1.0	-	3.0	V
R _{DS(on)}	Drain-Source On-State Resistance	V _{GS} =10V, I _D = 6.0A	-	19.5	24	mΩ
		V _{GS} =4.5V, I _D = 5.0A	-	29	38	
g _{fs}	Forward Transconductance	V _{DS} =5V, I _D = 6.0A	15	-	-	S
• Dynamic Characteristics^d						
C _{iss}	Input Capacitance	V _{DS} =20V, V _{GS} =0V, f=1MHz	-	516	-	pF
C _{oss}	Output Capacitance		-	82	-	
C _{rss}	Reverse Transfer Capacitance		-	43	-	
• Switching Characteristics^d						
Q _g	Total Gate Charge	V _{DS} =20V, I _D =6A, V _{GS} =10V	-	8.9	-	nC
Q _{gs}	Gate-Source Charge		-	2.4	-	
Q _{gd}	Gate-Drain Charge		-	1.4	-	
t _{d(on)}	Turn-on Delay Time	V _{DD} = 15V, R _L =2.5Ω V _{GS} =10V, R _{GEN} =3Ω	-	4.5	-	nS
t _r	Turn-on Rise Time		-	2.5	-	
t _{d(off)}	Turn-off Delay Time		-	14.5	-	
t _f	Turn-off Fall Time		-	3.5	-	
• Drain-Source Diode Characteristics^c						
V _{SD}	Drain-Source Diode Forward Voltage	V _{GS} =0V, I _S =6A	-	-	1.3	V

Notes:

- Repetitive Rating: Pulse width limited by maximum junction temperature.
- Surface Mounted on FR4 Board, t ≤ 10 sec.
- Pulse Test: Pulse Width ≤ 300μs, Duty Cycle ≤ 2%.
- Guaranteed by design, not subject to production

P-Channel Electrical Characteristics ($T_A=25^\circ\text{C}$, unless otherwise noted)

Symbol	Characteristic	Test Conditions	Min.	Typ.	Max.	Unit
• Off Characteristics						
BV_{DSS}	Drain-Source Breakdown Voltage	$V_{GS}=0V, I_D=-250\mu A$	-40	-	-	V
I_{DSS}	Zero Gate Voltage Drain Current	$V_{DS}=-32V, V_{GS}=0V$	-	-	-1	μA
I_{GSS}	Gate-Body Leakage Current	$V_{GS}=\pm 12V, V_{DS}=0V$	-	-	± 100	nA
• On Characteristics ^c						
$V_{GS(th)}$	Gate Threshold Voltage	$V_{DS}=V_{GS}, I_D=-250\mu A$	-1.0	-	-3.0	V
$R_{DS(on)}$	Drain-Source On-State Resistance	$V_{GS}=-10V, I_D=-5.0A$	-	32	38	m Ω
		$V_{GS}=-4.5V, I_D=-4.0A$	-	39	50	
g_{fs}	Forward Transconductance	$V_{DS}=-5V, I_D=-5.0A$	10	-	-	S
• Dynamic Characteristics ^d						
C_{iss}	Input Capacitance	$V_{DS}=-20V, V_{GS}=0V, f=1MHz$	-	940	-	pF
C_{oss}	Output Capacitance		-	97	-	
C_{rss}	Reverse Transfer Capacitance		-	72	-	
• Switching Characteristics ^d						
Q_g	Total Gate Charge	$V_{DS}=-20V, I_D=-5A, V_{GS}=-10V$	-	17	-	nC
Q_{gs}	Gate-Source Charge		-	3.4	-	
Q_{gd}	Gate-Drain Charge		-	3.2	-	
$t_{d(on)}$	Turn-on Delay Time	$V_{DD}=-20V, R_L=2.3\Omega, V_{GS}=-10V, R_{GEN}=6\Omega$	-	6.2	-	nS
t_r	Turn-on Rise Time		-	8.4	-	
$t_{d(off)}$	Turn-off Delay Time		-	44.8	-	
t_f	Turn-off Fall Time		-	16	-	
• Drain-Source Diode Characteristics ^c						
V_{SD}	Drain-Source Diode Forward Voltage	$V_{GS}=0V, I_S=-5A$	-	-	-1.2	V

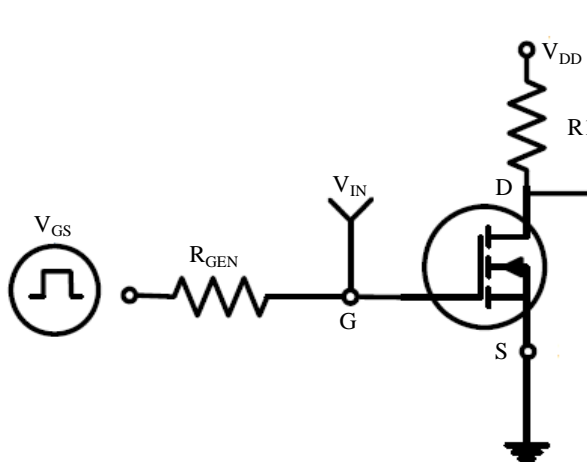

Switching Test Circuit

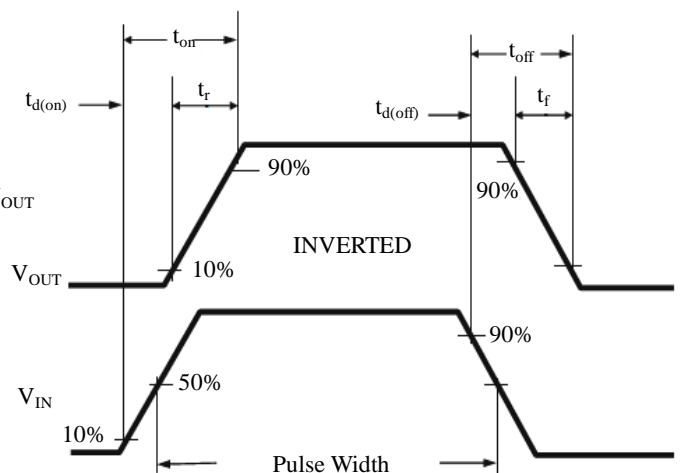

Switching Waveforms

Characteristics Curve (N-Channel)

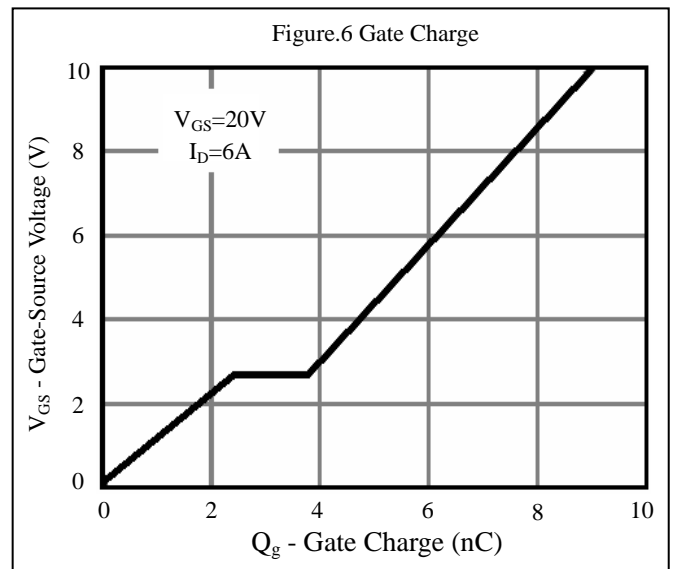
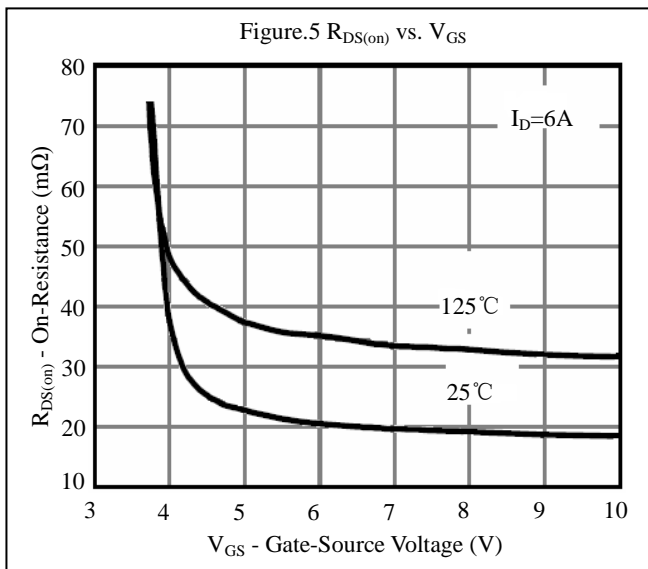
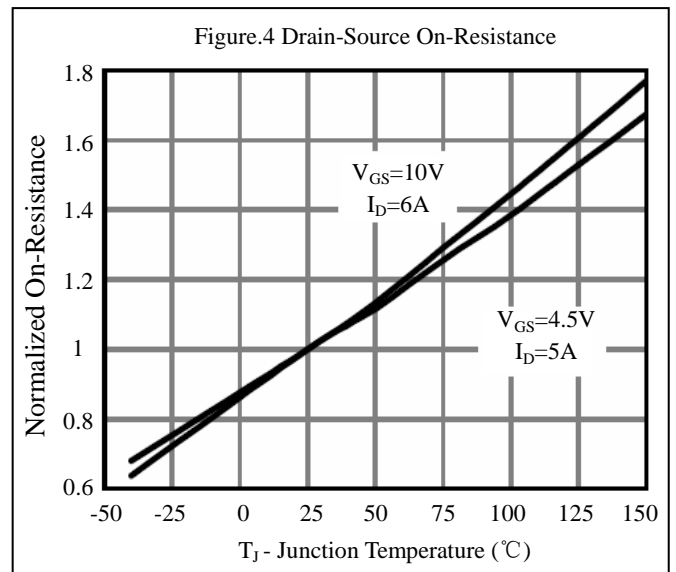
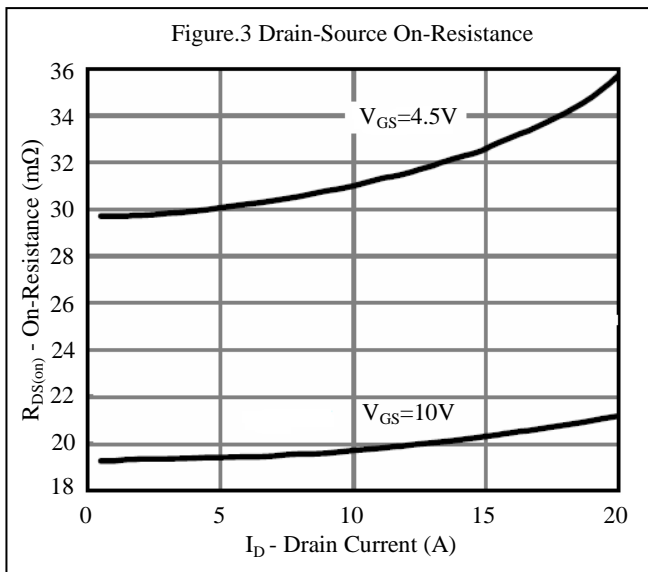
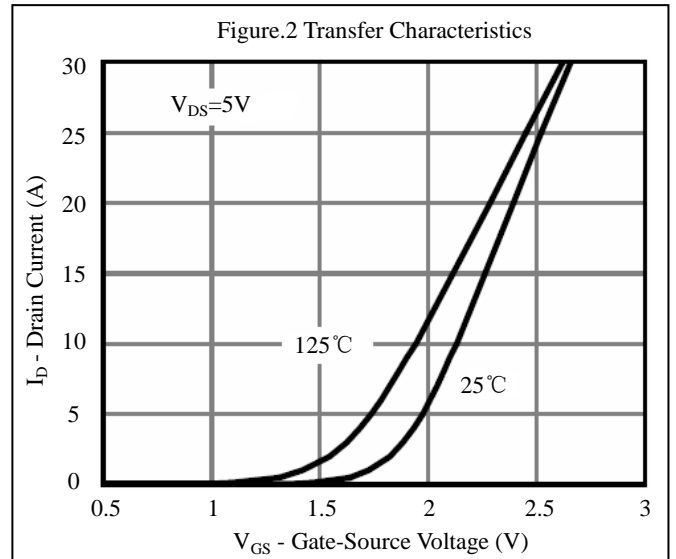
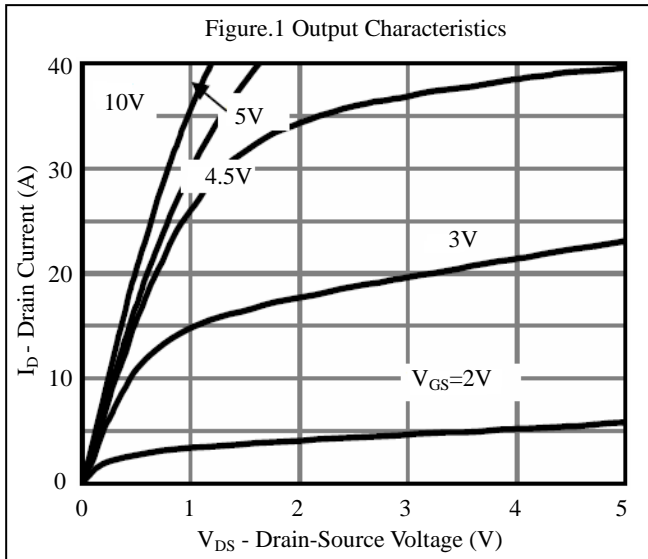

Characteristics Curve (N-Channel)

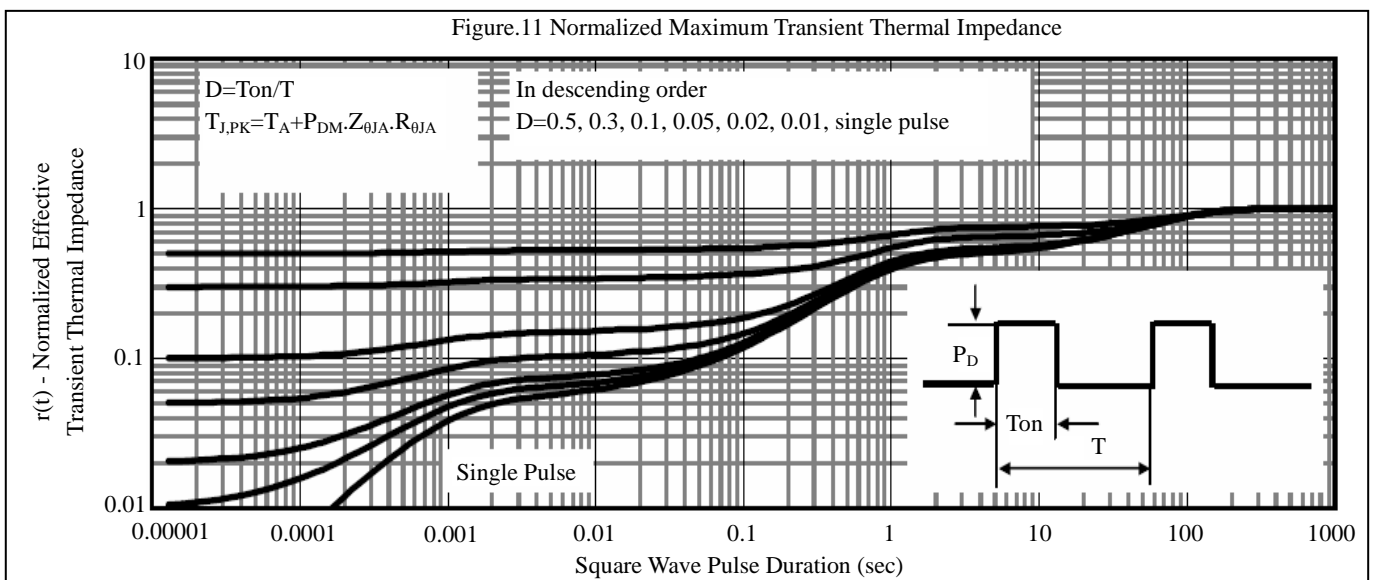
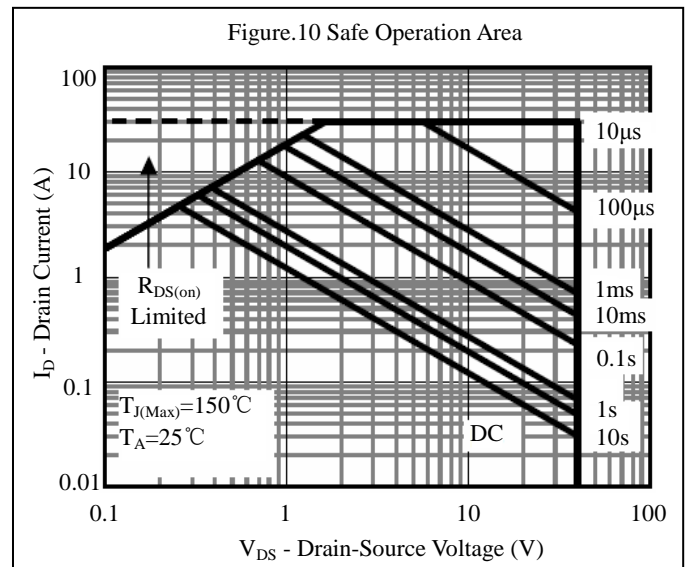
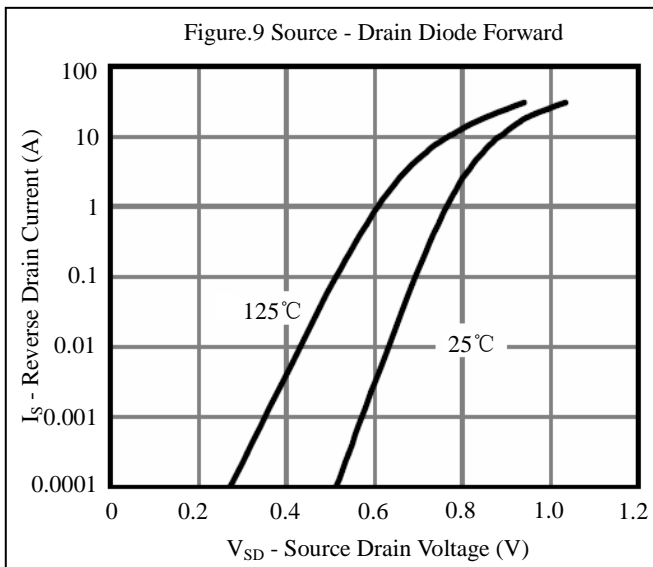
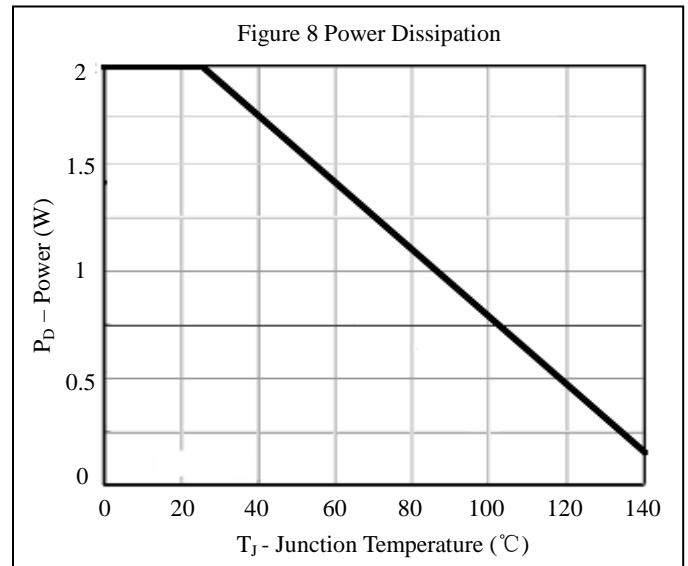
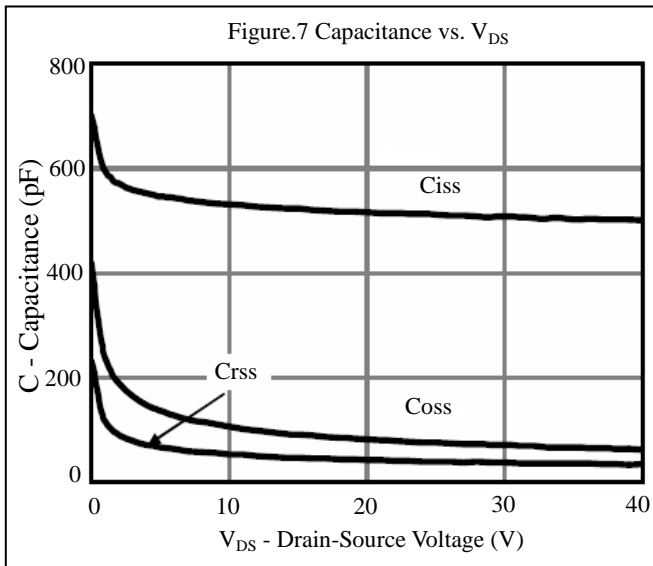

Characteristics Curve (P-Channel)

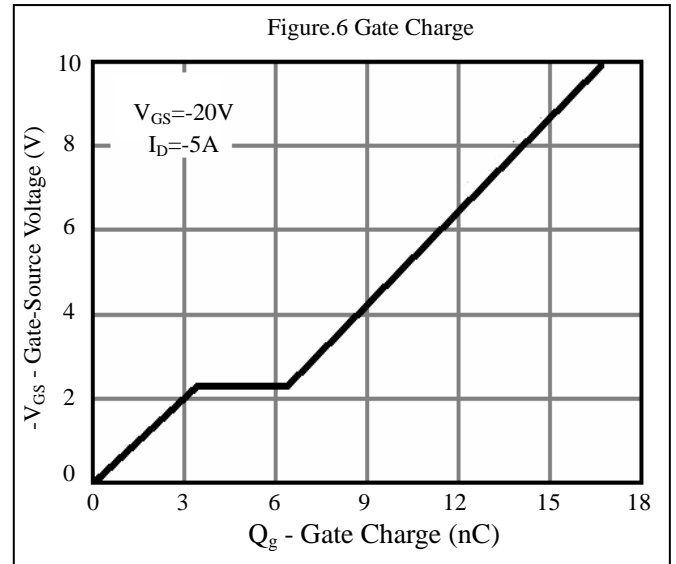
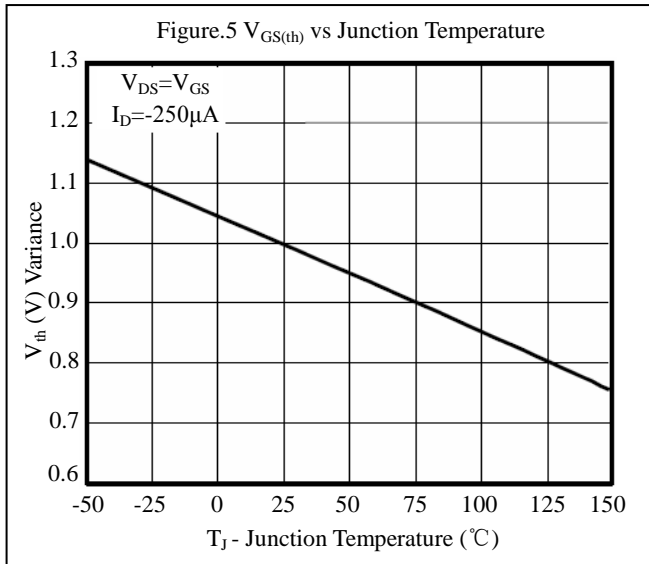
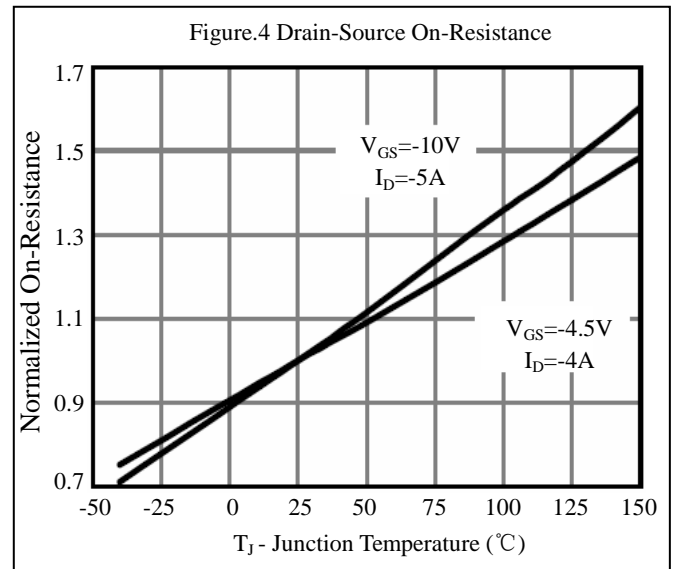
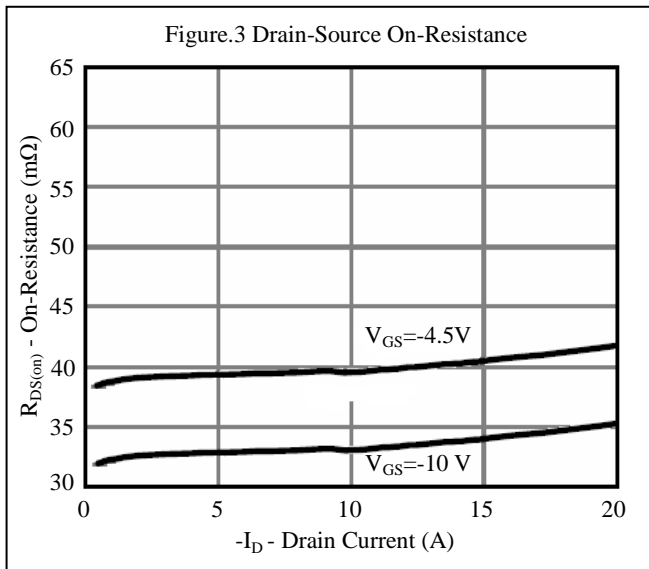
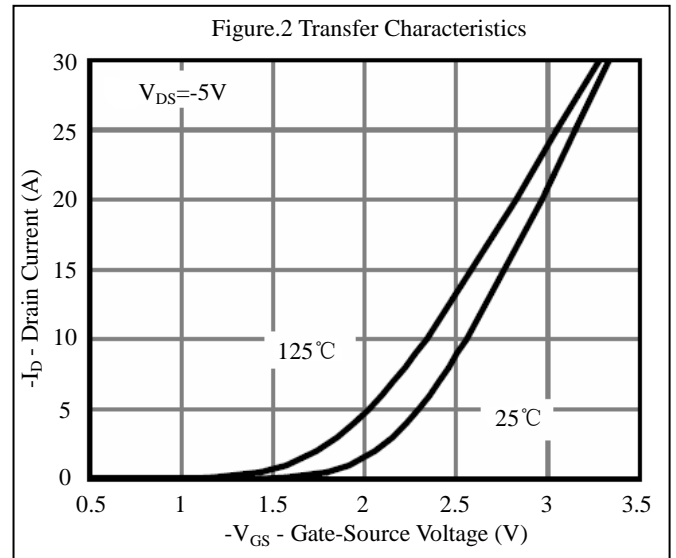
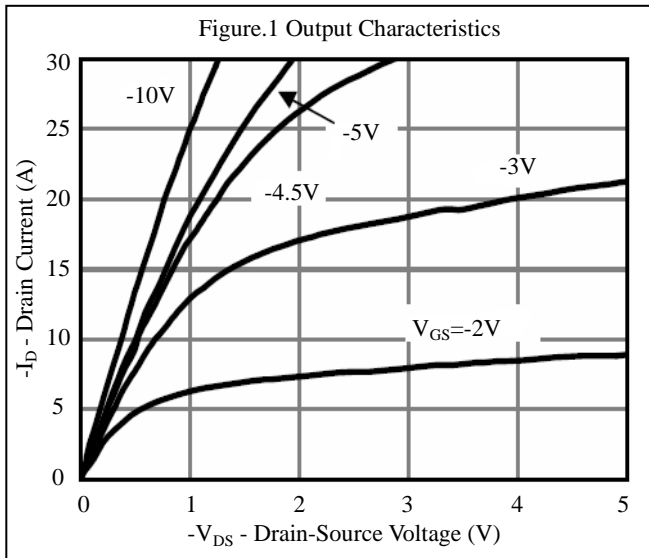

Characteristics Curve (P-Channel)

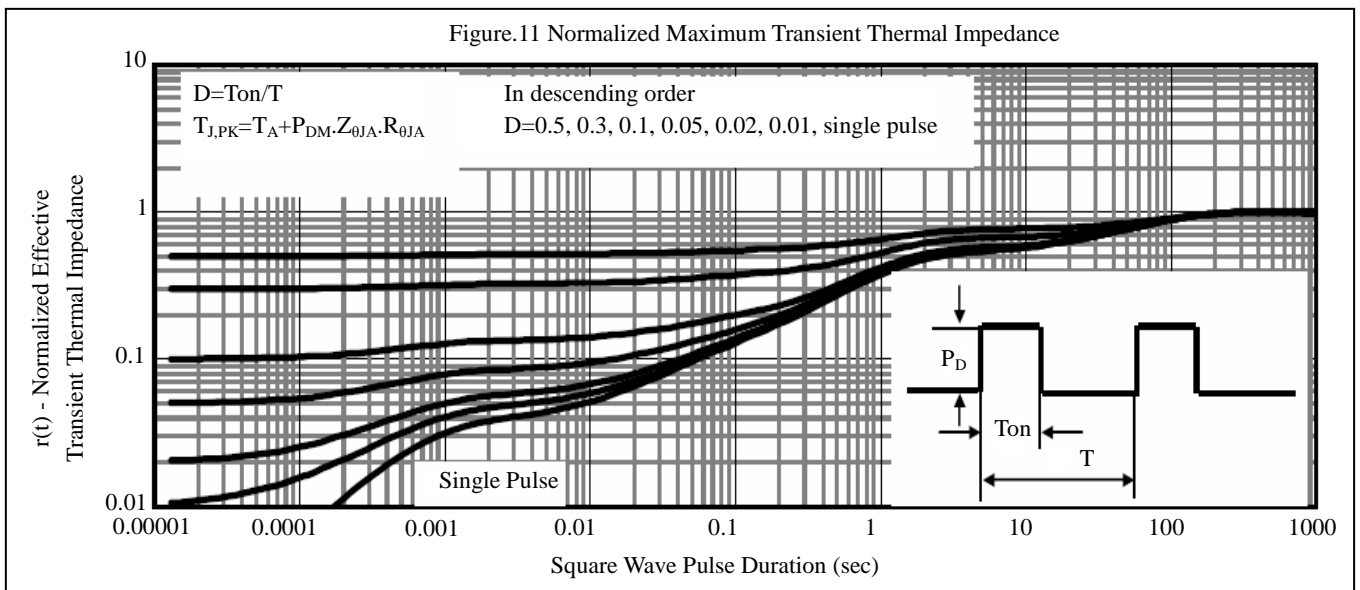
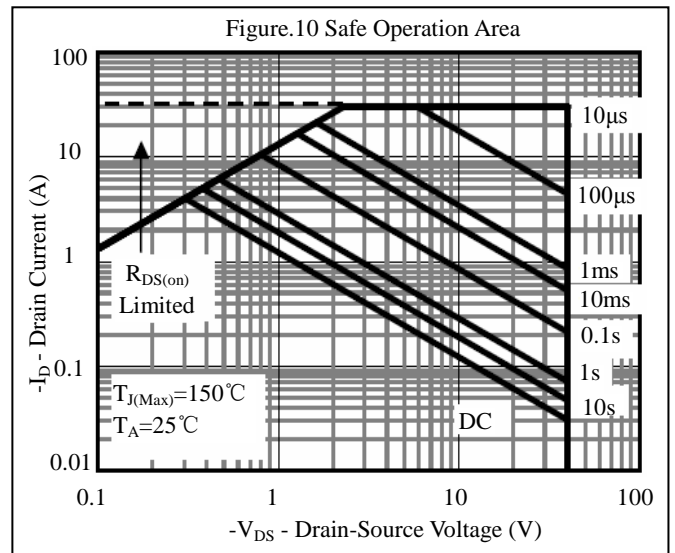
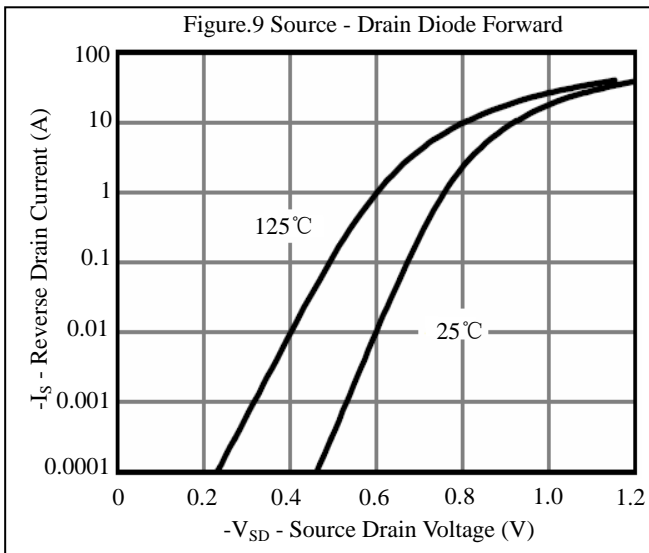
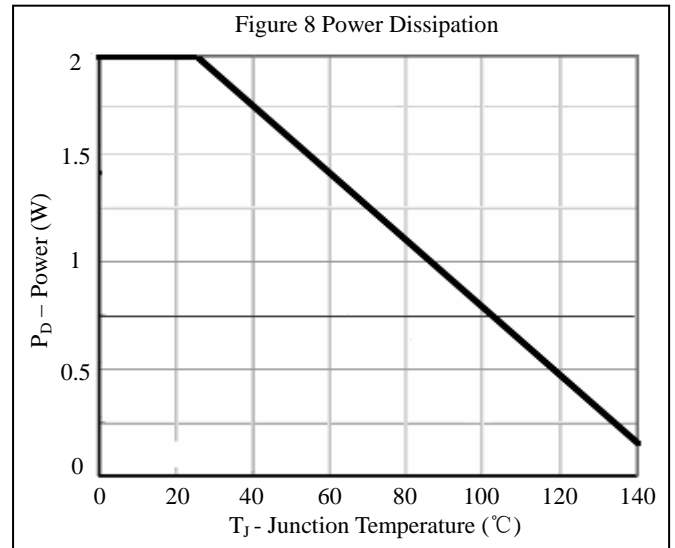
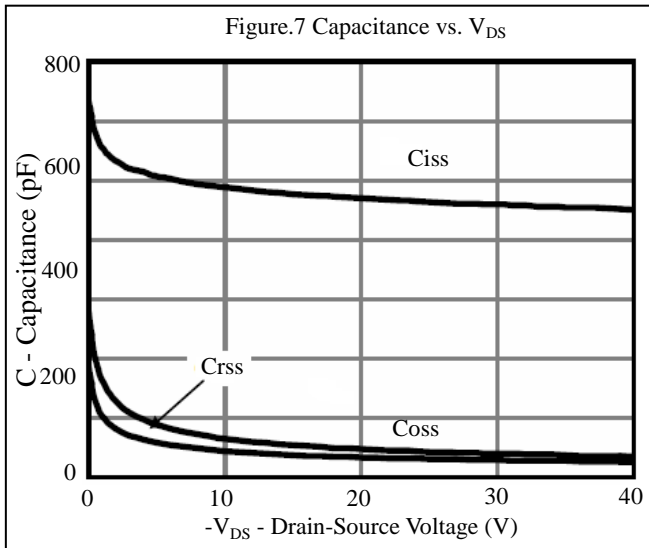

SOP-8 PACKAGE OUTLINE DIMENSIONS

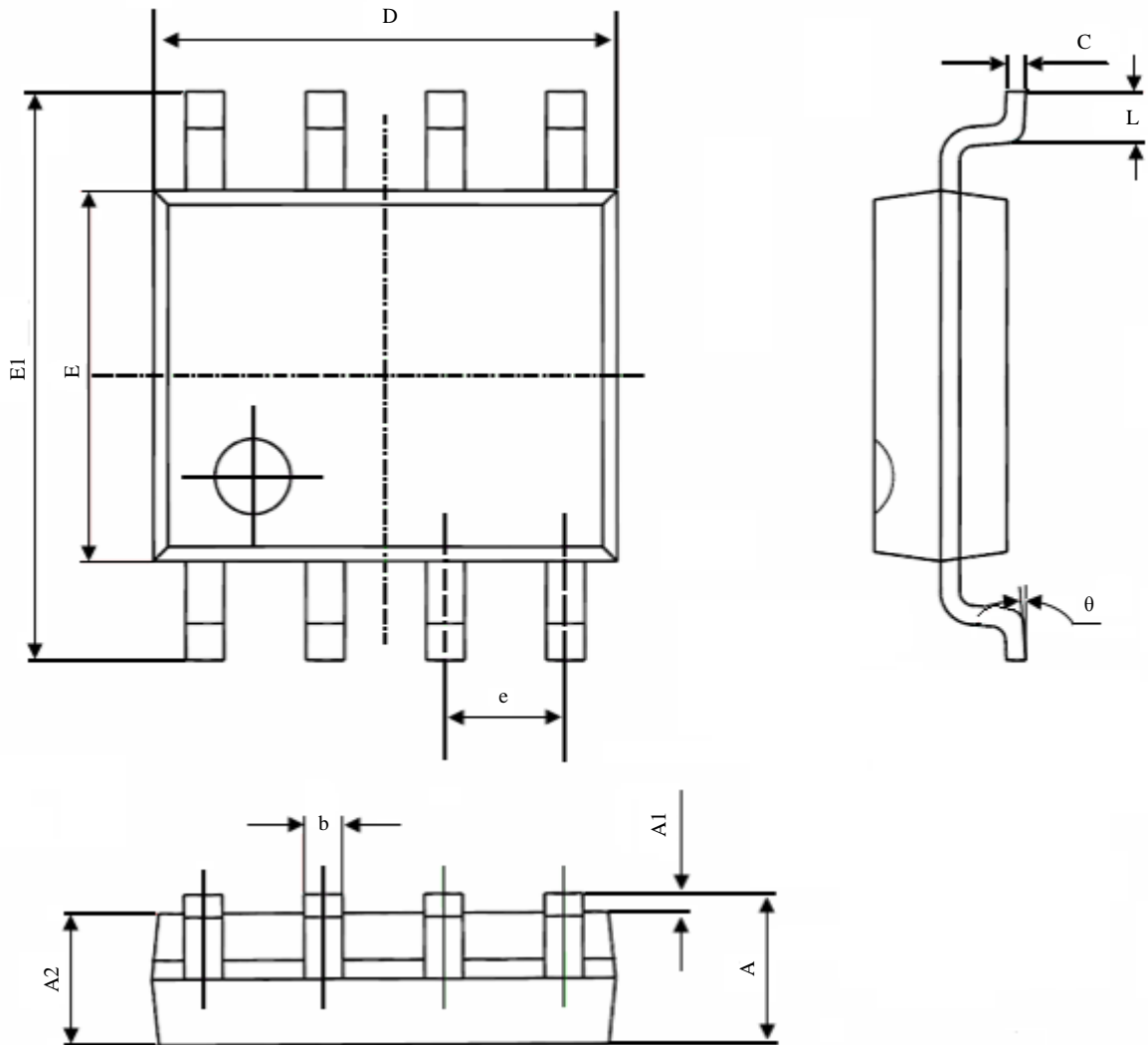

Symbol	Dimensions In Millimeters		Dimensions In Inches	
	Min.	Max.	Min.	Max.
A	1.350	1.750	0.053	0.069
A1	0.100	0.250	0.004	0.010
A2	1.350	1.550	0.053	0.061
b	0.330	0.510	0.013	0.020
c	0.170	0.250	0.006	0.010
D	4.700	5.100	0.185	0.200
E	3.800	4.000	0.150	0.157
E1	5.800	6.200	0.228	0.244
e	1.270(BSC)		0.050(BSC)	
L	0.400	1.270	0.016	0.050
θ	0°	8°	0°	8°



Notice

1. Specification of the products displayed herein is subject to change without notice. Continuous development may necessitate changes in technical data without notice. GEMMICRO or anyone on its behalf assumes no responsibility or liability for any errors or inaccuracies.
2. Stresses beyond those listed under “Absolute Maximum Ratings” may cause permanent damage to the device. These are stress ratings only and functional operation of the device at these or any other conditions beyond those indicated in the operational sections of the specifications are not implied. Exposure to absolute maximum rating conditions for extended periods may affect device reliability.